



NCD-694

# Instruction Manual

## IMPORTANT INFORMATION REQUIRED BY THE FCC

This device complies with Part 15 of the FCC Rules. Operation is subject to the following two conditions: (1) this device may not cause harmful interference; and (2) this device must accept any interference received, including interference that may cause undesirable operation.

NOTE: This equipment has been tested and found to comply with the limits for a Class B digital device, pursuant to Part 15 of the FCC Rules. These limits are designed to provide reasonable protection against harmful interference in a residential installation.

This equipment generates, uses and can radiate radio frequency energy and, if not installed and used in accordance with the instructions, may cause harmful interference to radio reception, which can be determined by turning the equipment off and on. The user is encouraged to try to correct the interference by one or more of the following measures:

- \* Reorient or relocate the receiving antenna.
- \* Increase the separation between the equipment and receiver.
- \* Connect the equipment into an outlet on a circuit different from that to which the receiver is connected.
- \* Consult the dealer or an experienced radio/TV technician for help.

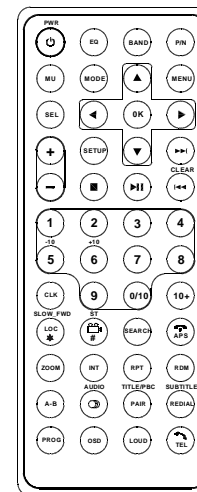
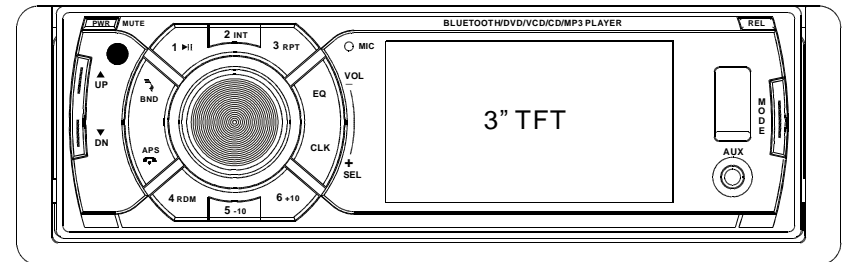

Fully Compatible to These  
Formats of Files: DVD,VCD,  
JPEG,MP4(AVI,ASF ,WMV,  
MPEG-1,MPEG-2,MPEG-4),  
MP3,WMA,CD.

3" LCD Display Full Fold Down Detachable  
PLL Electronics Tuning Stereo AM/FM Radio  
Multimedia Player With Aux-in Jack And Bluetooth

Remark: Any information subject to change without further notice

## PRECAUTION

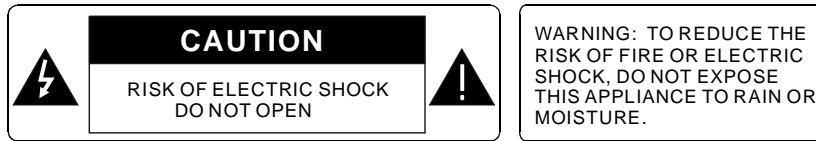

CAUTION: TO REDUCE THE RISK OF ELECTRIC SHOCK, DO NOT REMOVE COVER (OR BACK). NO USER SERVICEABLE PARTS INSIDE. REFER SERVICING TO QUALIFIED SERVICE PERSONNEL.

 The lightning flash with arrowhead symbol, within an equilateral triangle, is intended to alert the user to the presence of uninsulated dangerous voltage within the product's enclosure that may be of sufficient magnitude to constitute a risk of electric shock to persons.

 The exclamation point within an equilateral triangle is intended to alert the user to the presence of important operating and maintenance (servicing) instructions in the literature accompanying the appliance.

**CLASS 1 LASER PRODUCT**

Laser product symbol: located on the rear panel of the unit, indicate this player is a class laser product, only use weak laser and no hazardous radiation outside of the unit.

1. Read through this instruction manual before installation and use.
2. Before removing the unit, remove the disc from the unit first.
3. Do not open the cover or touch any of the components exposed out of the unit, only for qualified technicians.
4. Do not expose the unit to direct sunlight or nearby objects that radiate heat to avoid damage the unit.
5. Do not place the unit in moist and humid conditions.
6. Please ensure the ventilation holes are not covered to avoid overheating and malfunction.
7. Clear the panel and case with soft dry cloth only, do not apply any kind of thinner, alcohol or sprays.

## Contents

1. Before Operation.....	3
1.1 Glossary.....	3
1.2 Precautions.....	3
1.3 Maintenance and Cleaning of Discs.....	4
1.4 Battery Information of the Remote Control.....	4
1.5 The Remote Control Description.....	5
1.6 Description of the Face of the Front Panel.....	6
1.7 Description of the Rear Cabinet.....	7
1.8 Unit Installation.....	8
2. Common Operation.....	9
3. Radio Operation.....	11
4. Basic Disc, USB or MMC/SD Operation.....	12
4.1 Begin Playback.....	12
4.2 Pause Playback.....	13
4.3 Stop Playback.....	13
4.4 Select Chapter/Track with the UP/DN or the >> / << Buttons.....	13
4.5 Select Chapter/Track with the Number Buttons.....	13
4.6 Select Chapter/Track with the Root/PBC Menu.....	13
4.7 Terminate the Playback.....	14
5. Advanced Disc, USB or MMC/SD Operation.....	14
5.1 Playback with Speed.....	14
5.2 Playback with Slow Speed.....	14
5.3 Playback with still frame.....	15
5.4 Playback Repeatedly.....	15
5.4.1 One/All Repeat.....	15
5.4.2 A-B Repeat.....	15
5.5 Playback in Scan Mode.....	16
5.6 Playback from a specified Chapter/Track or a Specified Time.....	16
5.7 Playback in Random.....	16
5.8 Playback in Different Angle.....	16
5.9 Playback in Zoom Mode.....	16
5.10 Change the Caption Language.....	17
5.11 Change the Audio Language.....	17
5.12 Change the Video Signal System.....	17
5.13 Look over the Playback Status.....	17
5.14 Program Playback.....	18
5.15 Playback the Picture CD in JPEG Format.....	18
5.16 Mp4 OPERATION.....	19
5.17 ESP and ID3 Function.....	19
5.18 USB and MMC/SD Reader Operation.....	19
5.19 DVD System Menu Setup Operation.....	19
5.20 Region Code.....	23
6. Bluetooth Hand free System(Optional).....	24
7. Trouble Shooting.....	26
8. Specifications.....	27

## 1. Before Operation

### 1.1 Glossary

#### PBC (playback control)

It is a kind of signal(menu) recorded in the disc with SVCD or VCD2.0 format used for the playback control. For the discs containing PBC, It can playback interactive software with the menu displayed on monitor. And if the disc contain still images, it can playback high definition of still images.

#### Title

Generally, the title is the important part of DVD disc. for example, the theme part of movie is title 1, the part described how to make movie is title 2, the cast is title 3, etc. Every title contain a serial number that is easy to lookup.

#### Chapter

A title can be divided into several blocks, so that every block can be operated as a unit, the unit is called chapter. The chapter contain a unit at least.

#### Track

It is the biggest component of VCD. Generally, every song of karaoke disc is a track.

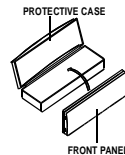

### 1.2 Precautions

#### **Safety**

1. Power Source: The unit should be connected to power supply only of the type described in the operating instructions or as marked on the unit.
2. The unit is designed for negative terminal of the battery which is connected to the vehicle metal. Please confirm it before installation.
3. Do not allow the speaker wires to be shorted together when the unit is switched on. Otherwise it may overload or burn out the power amplifier.
4. Do not install the detachable panel before connecting the wire.
5. The protective case is to safely keep the front panel(see the photo).

#### **Environment**

1. Do not use this unit when water and moisture is near it.
2. If moisture forms inside the Lens, it may not operate properly. To correct this problem, wait about one hour for the moisture to evaporate.
3. If the car interior is extremely hot, do not use the player until the car has been driven for a while to cool off the interior.

## 8. Specifications

### General Specification

Power Supply Requirement.....	DC 12V
Maximum Power Output.....	4 x 25W(measured at DC 14.4 V)
Dimensions(w x h x d).....	178 x 50 x 165mm

### DVD Deck Specification

Format.....	DVD/VCD/JPEG/MP4 (AVI, ASF , WMV, MPEG-1, MPEG-2, MPEG-4)/MP3/WMA/CD
Video System.....	NTSC/PAL/PAL-M/PAL-N/AUTO(optional)
Audio System.....	24 bit/96KHz
Loading System.....	Auto Loading
Mounting Angle.....	0 to +/-30

### Video Specification

Video Type.....	16:9 and 4:3
Video Output level.....	Composite:1.0± 0.2Vp-p Load impedance: 75 ohms
Horizontal Resolution.....	500

### Audio Specification

Audio Output(Analog audio).....	2.0 <sup>+0</sup> -1.0 Vrms
Frequency Response.....	20Hz ~ 20KHz(at 1KHz 0 dB)
S/N Ratio(Audio).....	≥90dB(at 1KHz 0 dB)
Separation.....	50dB

### Radio Specification

FM Section	
Frequency range.....	87.5MHz - 107.9MHz
Usable sensitivity.....	3uV
I.F Frequency.....	10.7MHz

### AM Section

Frequency.....	530KHz - 1710KHz
----------------	------------------

## 1.3 Maintenance and Cleaning of Discs

### Disc Maintenance

1. To keep the disc clean, handle the disc by its edge, do not touch the disc surface of the play side.
2. Do not stick paper or tape on the disc. If there is anything on the disc surface, wipe it up with a soft cloth before using.
3. Do not expose the disc to direct sunlight, or nearby heat sources such as caliduct, or leave it in a car parked in direct sunlight where there can be a considerable rise in temperature.
4. Put the disc inside disc case to keep temperature after finishing playback.

### Disc Cleaning

1. Before playing, wipe the disc with a clean cloth. wipe the disc outwards from the disc center.
2. Do not use petrol, thinner, commercial cleaner or anti-static spray used for plastic LP to wipe disc.

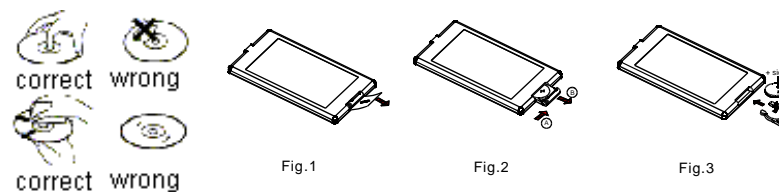

## 1.4 Battery Information of the Remote Control

### Replace Battery in the Remote Control:

1. Before using the remote control for the first time, pull the insulating sheet out of the remote control as the direction indicated by the arrow. (see fig. 1)
2. Press the movable block hold as the direction indicated by the A arrow (See fig. 2), then pull the battery holder out of the remote control as the direction indicated by the B arrow (see fig. 2).
3. Replace the old battery by a new battery with (+) polarity side upward. (See fig. 3).
4. Insert the battery holder to the original position in remote control. (See fig. 3).

### Note about the Battery of the Remote Control:

1. Lithium battery: CR 2025 3V.
2. Battery Life: 6 months with normal use in normal room temperature.
3. Improper use of battery may cause overheating or explosion, so that Result in injury or fire .
4. Battery leakage may cause damage to the remote control.
5. Do not short the battery.
6. Do not throw the battery into the fire.
7. To avoid the risk of accident, keep the battery out of reach of children.

## 1.5 The Remote Control Description

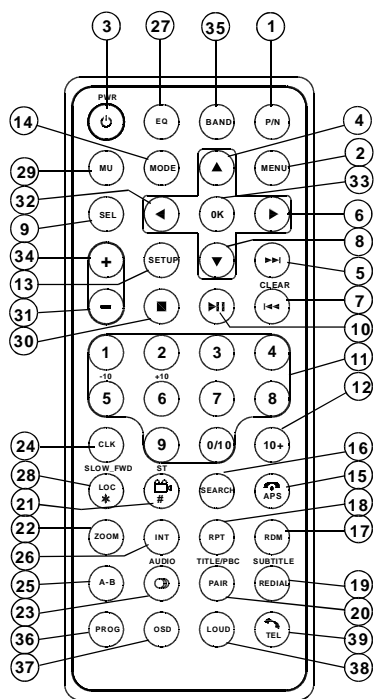

1. P/N BUTTON
2. MENU BUTTON
3. POWER BUTTON
4. ^ BUTTON
5. >>| BUTTON
6. > BUTTON
7. |<</CLEAR BUTTON
8. v BUTTON
9. SEL BUTTON
10. PLAY/PAUSE BUTTON
11. NUMBER(0~10,+10 -10) BUTTONS
12. 10+ BUTTON
13. SETUP BUTTON
14. MODE BUTTON
15. APS/HANG UP BUTTON
16. SEARCH BUTTON
17. RDM BUTTON
18. RPT BUTTON
19. SUBTITLE/REDIAL BUTTON
20. TITLE/PBC/PAIR BUTTON
21. ANGLE/ST/# BUTTON
22. ZOOM BUTTON
23. AUDIO BUTTON
24. CLK BUTTON
25. A-B BUTTON
26. INT BUTTON
27. EQ BUTTON
28. LOC/SLOW-FWD/\* BUTTON
29. MUTE BUTTON
30. STOP BUTTON
31. VOLUME- BUTTON
32. < BUTTON
33. OK BUTTON
34. VOLUME+ BUTTON
35. BAND BUTTON
36. PROG BUTTON
37. OSD BUTTON
38. LOUD BUTTON
39. TEL BUTTON

## 7. Trouble Shooting

Please read the user manual carefully before using the DVD player. If you have any trouble using this player, try to solve the problems by the suggestions mentioned below. If you can not remove the trouble after using all the suggestions, please contact the company or the technical service center authorized by us. For the sake of your safety, please do not open the cover and repair the player by yourself, if that, it may cause electric shock.

### NO PICTURE, SOUND AND INDICATION

- \* Ensure that the power switch is on.
- \* Ensure that the power cord is not damaged or the fuse is not blown.
- \* Ensure that the power plug is connected to the inlet tightly.

### NO SOUND BUT HAVE PICTURE

- \* Ensure that the player's audio output has a good connection with amplifier.
- \* Check whether the audio connector is damaged.
- \* Check whether you have turned down the volume.
- \* Ensure that you have set the right AUDIO setup of the player.
- \* Ensure that the audio is not muted.

### NO PICTURE BUT HAVE SOUND

- \* Ensure that the player's video output has a good connection with monitor's video input.
- \* Ensure that you have turned your TV to the AV input channel connecting to your player.
- \* Check whether the video connector is damaged.
- \* Ensure that you have set the right VIDEO settings of the player.

### BLACK AND WHITE PICTURE OR SCREEN ROLLING

- \* Ensure that you have set the right TV SYSTEM (e.g. PAL, NTSC) setting.

### FLAWS OF PICTURE OR SOUND

- \* Check whether the setting of AUDIO is right.
- \* Check whether the disc is scratched or stained.
- \* Check whether the AV connector and the output terminal is stained.
- \* Check whether there is condensation inside the Lens. If so, leave the player off for an hour or so, then try again.
- \* Check whether the installation angle is less than 30.

### DISPLAY NO DISC OR BAD DISC

- \* Ensure that you have put the disc in the unit.
- \* Check whether the disc is put in the reverse side.
- \* Check whether the disc is distorted.
- \* Check whether the disc is stained or scratched badly.
- \* Ensure that the disc format is compatible to the player.
- \* Ensure that the temperature inside the car is not too high. If so, cool off until the ambient temperature returns to normal.
- \* Replace another disc to insert it into the disc compartment.

### REMOTE CONTROL IS INSENSITIVE OR DOES NOT WORK

- \* Check the batteries of remote control and make sure that they are powerful and have good conductivity.
- \* Direct the remote control to the IR sensor of the player.
- \* Check whether there are some obstacles between the remote control and IR sensor.

### SOME FUNCTION BUTTONS DO NOT WORK

- \* Turn off the power, then turn on again.
- \* Reset the unit to zero, then turn on again.
- \* Remove the front panel from the unit, then install it again and then turn on again.

### THE RADIO DOES NOT WORK

- \* Check whether the antenna cable is connected firmly. Or manually tune for a station.

#### 4.3 To redial the last phone number dialled

- (1) Short press TEL button . It will show a line on LCD.
- (2) Short press REDIAL button, It will dial the last phone number.

#### 5. Accept/Reject/End Call

- 5.1 During ringing, short press TEL button to accept the call
- 5.2 During ringing, short press HANG UP button to reject the call
- 5.3 During talking, short press HANG UP button to end the call

Note: During ringing, the phone number appears.

#### 6. Dialling or receiving call at unit sleep mode

When the car audio at sleep mode (Acc on and standby), to execute a dialling (with mobile phone) or there comes a call, the car audio will temporarily woke up.

#### 7. To transfer the audio of a file played by Mobile Phone to the Car Audio Player

In the connection status between the Bluetooth devices of the Car Audio Player and a Mobile Phone, if the mobile phone can play audio or video files and support A2DP, when the Mobile Phone plays an audio or video file(For some Mobile Phones, you must select Play by BT firstly), the audio of the playing file will be transferred to the Car Audio Player.

In A2DP mode, if the Bluetooth device of the Mobile Phone support AVRCP, the functions of the >>|, |<<, PLAY/PAUSE, EJECT, MUTE, EQ, LOUD, VOL and SEL buttons are the same as one in disc mode(no fast forward/backward functions for the >>|/|<< buttons). The other buttons available in disc mode are not available.

#### 1.6 Description of the Face of the Front Panel

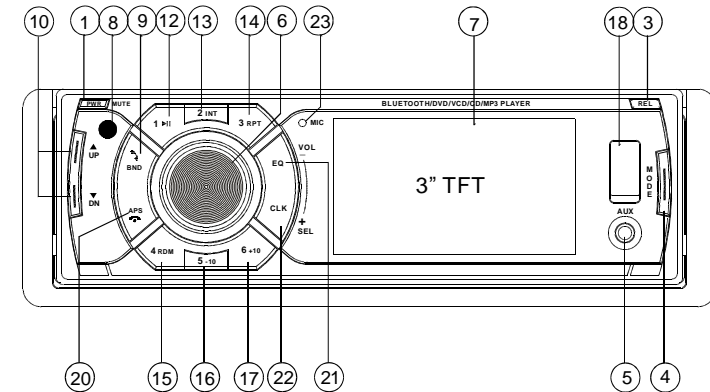

The figure of the front panel

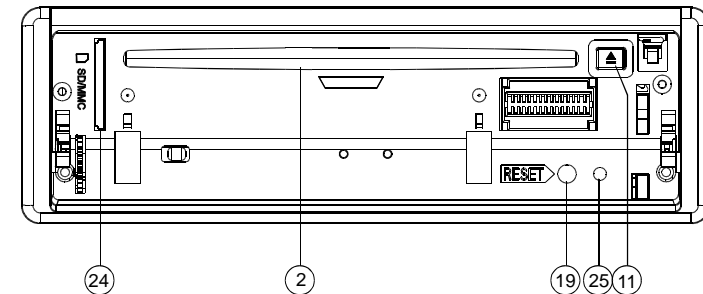

The figure of the Unit Chassis Facet After removing the Front Panel

- |                               |                        |
|-------------------------------|------------------------|
| 1. POWER/MUTE BUTTON          | 13. 2/INT BUTTON       |
| 2. DISC SLOT                  | 14. 3/RPT BUTTON       |
| 3. RELEASE BUTTON             | 15. 4/RDM BUTTON       |
| 4. MODE                       | 16. 5/-10 BUTTON       |
| 5. AUX IN SOCKET              | 17. 6/+10 BUTTON       |
| 6. SEL BUTTON<br>AND VOL KNOB | 18. USB SOCKET         |
| 7. SMALL MONITOR              | 19. RESET BUTTON       |
| 8. IR REMOTE SENSOR           | 20. APS/HANG UP BUTTON |
| 9. BAND/TEL BUTTON            | 21. EQ BUTTON          |
| 10. UP AND DN BUTTONS         | 22. CLK BUTTON         |
| 11. EJECT BUTTON              | 23. MICROPHONE         |
| 12. 1/PLAY/PAUSE BUTTON       | 24. CARD SLOT          |
|                               | 25. LED Indicator      |

## 1.7 Description of the Rear Cabinet

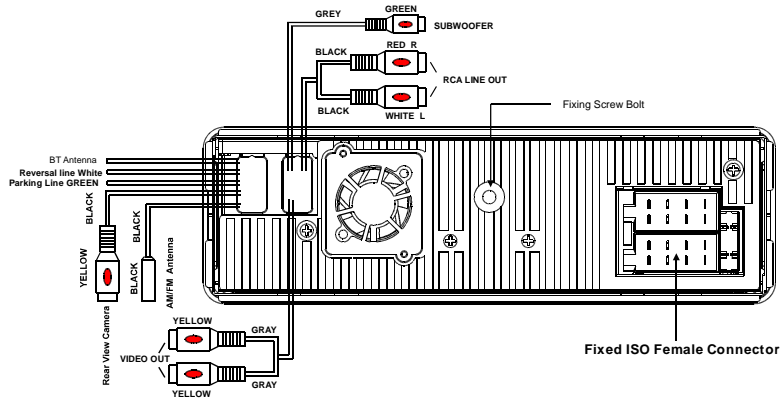

- Note:1. Parking wire must be connected, and the parking brake must be engaged in order for the monitor to work  
 2. Use the clip end of the Ground wire provided by manufacturer to connect Mounting Screw, use the other end of the Ground wire to connect the negative pole of the power source. Otherwise, the video on screen may flashes.

### Connecting the parking brake line to the parking brake system built in the car

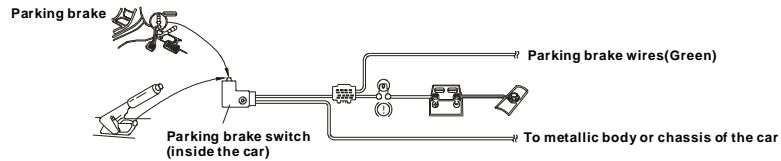

### The Description of the Fixed ISO Female Connector

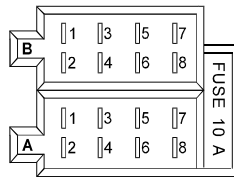

#### CONNECTOR A

- 1.
- 2.
- 3.
4. Memory +12V(yellow)
5. Auto Antenna(blue)
- 6.
7. 12V (To Ignition Key)(red)
8. GROUND(black)

#### CONNECTOR B

1. Rear Right Speaker (+)
2. Rear Right Speaker (-)
3. Front Right Speaker (+)
4. Front Right Speaker (-)
5. Front Left Speaker (+)
6. Front Left Speaker (-)
7. Rear Left Speaker (+)
8. Rear Left Speaker (-)

## 6. BLUETOOTH HANDFREE SYSTEM(Optional)

### 1. Pairing and connection

- 1) Turn on the Bluetooth mode of the mobile phone;
- 2) Select the item of Finding the BLUETOOTH Device and press enter. Once the device and unit are paired, the unit will display the name of the device. Select the device and press enter, and the unit will ask for a password which is 0000. After entering 0000, press enter and after the pairing is complete the unit will display "Pairing is OK".
- 3) For some mobile phones, they can automatically connect with the BT device of the car audio system after pairing is ok; for some mobile phones, they need to select the paired BT device and press the CONNECTION button. When connection is ok, the LCD of the car audio system will show LINK OK.

\* when pairing is failed, long press the MODE button on the front panel or PAIR button on the remote control to enter pairing mode, then the LCD will display PAIR STAR, then pair and connect with mobile phone again.

\* In Disc mode, press and hold the PAIR button for 3 seconds to enter Pairing mode.

### 2. Using the mobile phone for connecting and disconnecting.

In the connection status, find the paired and connected Bluetooth Device, then press the disconnection button to disconnect.

In the disconnection status, find the paired and disconnected Bluetooth Device, then press the connection button to connect.

### 3. In the connection status: Mobile phone transfers to the car audio whenever a dialling takes place; Mobile phone transfers to the car audio whenever receiving a call.

### 4. Dialling when in connection status

#### 4.1 Dial with the mobile phone directly.

#### 4.2 Dial with remote control with the following procedures:

- (1) Short press TEL button, then a line will appear on LCD.
- (2) Input telephone number with number buttons 0-9
  - \* Short press CLEAR button to cancel the wrongly input number if necessary
- (3) Short press TEL to execute the dialling.



## 5.20 The Region Code

Q: Why does the unit display REGION ERROR after inserting disc into disc compartment ?

A: Because the DVD player and disc has respective region code. If the region codes of them do not match with each other, the DVD player can not play the disc.

Appendix: The region code of DVD:

The Motion Picture Association of America (MPAA) divided the world into 6 regions, and gave every region a code, namely region code. The region codes and the countries or areas represented by the region codes are as follows:

Region 1: America, Canada, East-Pacific Inlands;

Region 2: Japan, West Europe, North Europe, Egypt, South Africa, Middle East;

Region 3: South-east Asian countries include Taiwan, Hong Kong, South Korea, Thailand, indonesia, etc.;

Region 4: Australia, New Zealand, Central South America, South Pacific Inlands;

Region 5: Russia, Mongolia, Indian Peninsula, Middle Asia, East Europe, North Korea, North Africa, North-west Asia etc.;

Region 6: China mainland.

## 1.8 UNIT INSTALLATION

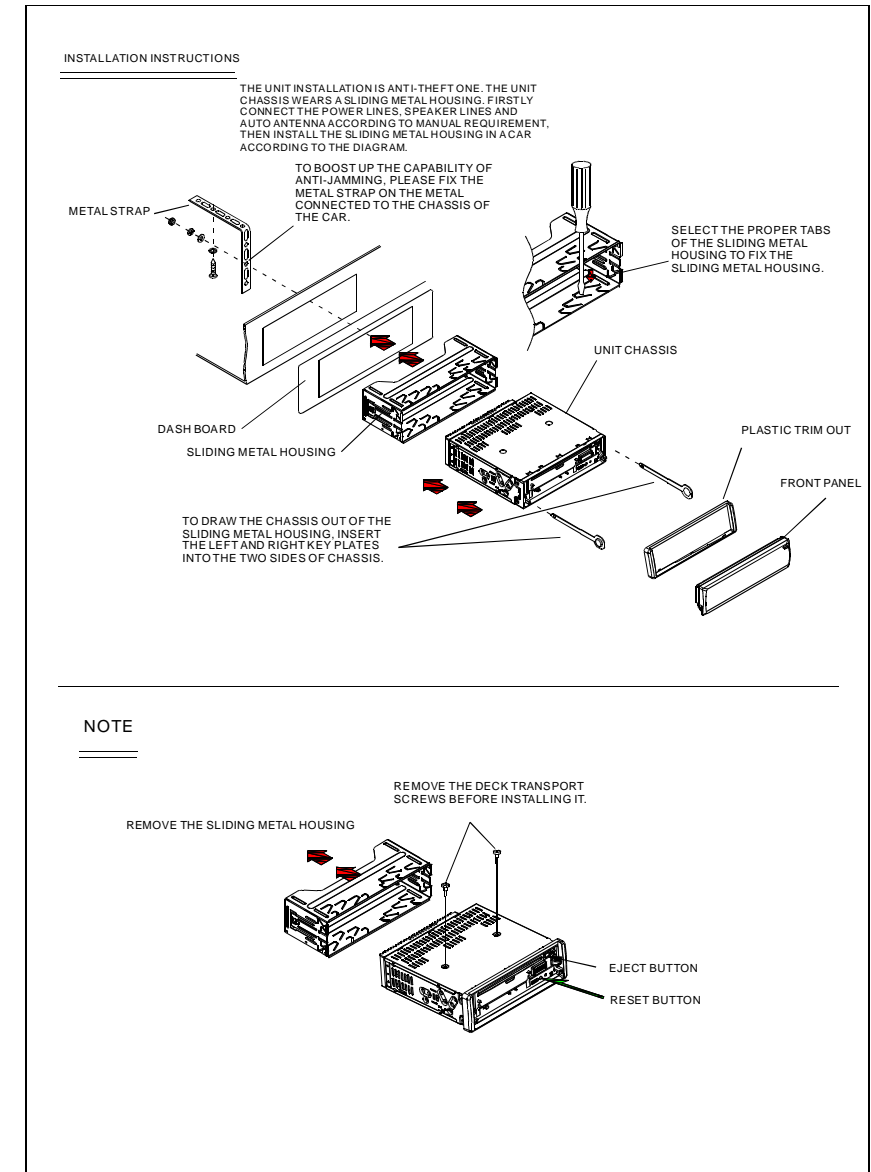

## 2. Common Operation

- To turn on/off the unit  
Under power off mode, press the POWER button to turn on the unit.  
  
Under power on mode, long press the POWER button on the front panel or briefly press the POWER button on the remote control to turn off the unit.
- To select function mode  
Press the MODE button to select TUNER, DISC(After inserting a disc), USB (After inserting a USB storage), Card(After inserting a MMC or SD card) or AUX mode.
- To adjust sound level  
Rotate the VOL knob on the front panel or press or hold the + or - button on the remote control to directly adjust the volume level.
- To mute sound  
Press the MUTE button on the remote control to turn on/off MUTE mode. Briefly pressing the POWER button on the front panel also can turn on/off MUTE mode.  
  
In MUTE mode, the MUTE mode can be released by pressing the following buttons: MUTE, VOL or +/-, SEL, MODE.
- To display and adjust the clock time  
Press the CLK button to display clock time on the small monitor of the front panel.  
  
Then long press the CLK button to change the color of the hour of the clock, then rotate the VOL knob on the front panel or press the + or - button on the remote control to adjust the hour; and then briefly press the SEL button to change the color of the minute of the clock, then rotate the VOL knob on the front panel or press the + or - button on the remote control to adjust the minute.
- To select a preset EQ mode  
Press the EQ button to select the preset music equalizer curves: POP, ROCK, CLAS, FLAT . The sound effect will be changed.

### HUE

It is for adjusting the hue of the video output.

### SATURATION

It is for adjusting the saturation of the video output.

### SHARPNESS

It is for adjusting the sharpness of the video output.

#### 5.19.5 SPEAKER SETUP

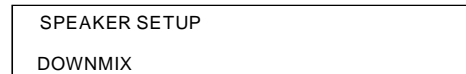

#### DOWNMIX

It is for selecting your desired sound effect when there is not central speaker and sub-woofer. There are 3 mode: LT/RT, STEREO, VSS.

LT/RT: When playing a disc with PRO LOGIC Dolby stereo effect, choose the item, so it will output audio signal with vivid theatre effect.

STEREO: If you choose the item, when outputting audio signal with 5.1 channels, it will output the left and right channels of signal ; when outputting audio signal with 2 channels, it will output the common 2 channels of stereo signal.

VSS: If you choose the item, when playing a disc recorded with 5.1 channels, the main channel speakers can output audio signal with VSS effect.

#### 5.19.6 DIGITAL SETUP

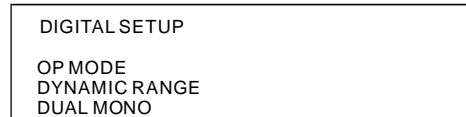

#### OP MODE

It is for selecting audio output mode

LINE OUT: It can linearly compress the audio signal. So the volume level is lower.

RF REMOD: It can make the volume level higher.

#### DYNAMIC RANGE

After selecting the compression mode of LINE OUT, set the item, so you can adjust the linear compression ratio. If you set it to be FULL, the Peak-to-Peak value of the audio signal is the minimum; if you set it to be OFF, the Peak-to-Peak value is the maximum.

#### DUAL MONO

It is for selecting a desired audio output mode for the left and right ways of signal. There are 4 modes in all as follows: STEREO, MONO L, MONO R, MIX MONO.

### 5.19.2 LANGUAGE SETUP

#### LANGUAGE SETUP

OSD LANGUAGE  
AUDIO LANG  
SUBTITLE LANG  
MENU LANG

#### OSD LANGUAGE

This item is for selecting the language of the SYSTEM MENU and all operating prompt interface displayed during playback.

#### AUDIO LANG

This item is for selecting a audio language.

#### SUBTITLE LANG

This item is for selecting a subtitle language.

#### MENU LANG

This item is for selecting a disc menu language.

### 5.19.3 AUDIO SETUP

#### AUDIO SETUP

AUDIO OUT  
KEY

#### AUDIO OUT

there is only ANALOG mode, i.e. SPDIF/OFF, not optional.

#### KEY

It is for selecting your desired basic music tone(from low to high).

### 5.19.4 VIDEO SETUP

#### VIDEO SETUP

BRIGHTNESS  
CONTRAST  
HUE  
SATURATION  
SHARPNESS

#### BRIGHTNESS

It is for adjusting the brightness of the video output.

#### CONTRAST

It is for adjusting the contrast of the video output.

#### 7. To demount the front panel

- 1) Press the RELEASE button on the front panel to detach the front panel from the unit;(see fig. 1)
- 2) Flip down the front panel;(see fig. 2)
- 3) Hold the right end of the front panel and pull out the right end as arrow direction, then pull out the whole front panel as arrow direction.(see fig. 3)

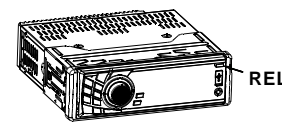

Fig. 1

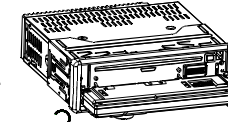

Fig. 2

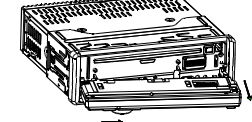

Fig. 3

#### 8. To mount the front panel

- 1) Insert left end of the front panel first as arrow direction, then push and hook up the right end of the front panel onto the unit;(see fig. 4)
- 2) Flip the front panel upward till hearing a clip.(see fig. 5 and fig. 6)

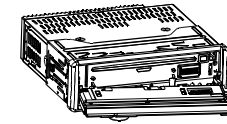

Fig. 4

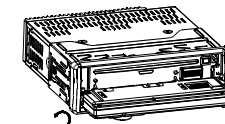

Fig. 5

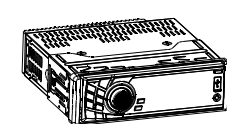

Fig. 6

#### 9. To turn on/off LOUD mode

Press the LOUD button on the remote control to turn on/off LOUD mode.

When turning on LOUD mode, it will enhance bass level immediately when the bass is not enough.

#### 10. To reset the unit

when the display is wrong or the function buttons are not effective or sound is distorted, press the RELEASE button to detach the front panel from the unit, then use a needle analogue to press the RESET button to rehabilitate the distorted program to zero.

#### 11. To adjust the sound equalizer curves

To adjust the sound equalizer curves, briefly and repeatedly press the SEL button to select the sound equalizer curves of VOL, BAS(without preset EQ), TRE (without preset EQ), BAL, FAD, then rotate the VOL knob on the front panel or press the + or - button to adjust level.

### 3. Radio Operation

#### 1. BAND BUTTON

In RADIO mode, press the BAND button on the remote control or on the front panel to select your desired radio band of FM1, FM2, FM3, AM1 and AM2, and the word means which band is selected will be displayed on the small monitor of the front panel.

#### 2. TUNE/SEEK UP/DOWN BUTTONS

In RADIO mode:

- 1) Long press the UP/DN button on the front panel or the >>|/|<< button on the remote control to automatically search up/down for a available station from the current frequency.
- 2) Briefly press the UP/DN button on the front panel or the >>|/|<< button on the remote control to manually search up or down with step by step for your desired station from the current frequency.

#### 3. APS BUTTON

In RADIO mode:

- 1) When long pressing the APS button, the radio searches from the lowest frequency and checks the signal strength level until 1 cycle search is finished. And then the 6 strongest stations are preset to the corresponding preset number memory bank. The AS operation is implemented in the each bank of the selected band. When the AS operation is finished, it will resume broadcasting on the M1.(It can store 3x6 stations for FM and 2x6 stations for AM in all)
- 2) When briefly pressing the APS button , the radio searches for each preset station from the M1. When the field strength level is more than the threshold level of the stop level, the radio is holding at that preset number for few seconds with releasing mute, and then searches again. After finishing a circle of searching, it will stop searching on the M1.

NOTE: In FM band, FM1,FM2,FM3 is checked one at a time.  
In AM band, AM1, AM2 is checked one at a time.

#### 4. PRESET STATION [ 1-6 ] BUTTONS

In RADIO mode:

- 1) To memorize the current frequency on the current band, long press any one of the six preset buttons (1-6) .
- 2) To recall the preset memory on the current band, press one of the preset buttons [1-6] .

#### 5. STEREO/MONO BUTTON

Press the ST button on the remote control to select the STEREO or MONO sound mode for FM band.

#### 6. LOC BUTTON

- 1) In RADIO mode, when the signal of the distance radio station are very weak and the receiving effect is bad during tuning, check whether there is the word LOC on LCD. If there is the word LOC on LCD, press this button to turn off the LOC function, then tune again for the distance radio station;
- 2) In RADIO mode, when the signal of the local radio station are too strong to lead that the interference to the receiving effect during tuning, press this button to turn on the LOC function to display the word LOC on LCD, then tune again for the local radio station.

For the DVD System Menu, there are 6 setup pages in all. They display as follows:

#### 5.19.1 SYSTEM SETUP

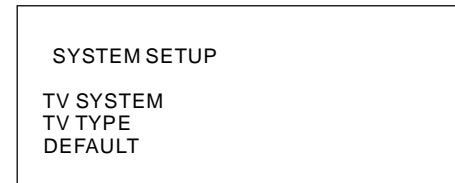

#### TV SYSTEM

This product supports output of various TV system.

If your TV set has only NTSC or PAL system, the screen will blink and become colorless when a wrong TV system is selected. In this case, press the N/P button to switch the right TV system to match the TV color system.

#### TV TYPE

The setup item is for matching TV screen size.

4:3 PS: Choose the item when connecting a TV set with 4:3 screen. When playing the pictures with 16:9 size, the left and right parts of the video will be cut out, and display in full screen.

4:3 LB: Choose the item when connecting a TV set with 4:3 screen. When playing the pictures with 16:9 size, the top and bottom parts of the TV screen will be turned into a black square respectively.

16:9: Choose the item when connecting a TV set with 16:9 wide screen.

#### DEFAULT

This item is for making all setup items change back to original status.

3. During JPEG playback, press one of the >/</^/∨ buttons to change the angle of viewing picture that is displaying as follows:  
 >: 90 deg cw; <: 90deg ccw; ^:UP<-->DOWN; ∨: LEFT<-->RIGHT  
 During JPEG playback, press the PROG button to change the mode of refresh picture.  
 During JPEG playback, press the STOP button to stop playing and return to the root menu.
- \* During JPEG playback, the following buttons are not available: SLOW-FWD, SUBTITLE, TITLE, ANGLE, STEP, AUDIO, RDM, INT and A-B.
- \* In JPEG mode, the other operations are same as ones in MP3/WMA mode.

#### 5.16 MP4 Operation

1. The root menu will display on the monitor when it begins to switch to DISC mode, then it will automatically play the first file.  
 During playback, press the STOP button to stop playing and return to the root menu.
2. When displaying the root menu, press the direction buttons to select your desired FOLDER or file, then press the OK or PLAY button to open the FOLDER, or play the selected file.  
 When displaying the root menu, you can also use the number buttons to select the serial number of the file and play the file.
- \* The ANGLE, PROG, RDM, INT and TITLE/PBC button are not valid in this mode.
- \* The other functions are same as ones in DVD disc; but the RPT function is same as one in MP3/WMA.

#### 5.17 ESP and ID3 Function

There is ESP function for all formats of discs.

In MP3/WMA mode, during playback, the information of the file name, folder name, songs title, artist and album will be scrolling on the LCD display. As long as the current playing MP3 music contains relevant ID3 tag information in version 1.0/2.0 format, the 3 items underlined above will be scrolling on the LCD display; otherwise, they will not.

#### 5.18 USB and MMC/SD Reader Operation

Power on the DVD player, then insert the USB storage or MMC/SD Card (first flip down the front panel), and then the monitor will display the root menu of the USB storage or MMC/SD Card.

All the operations are same as ones of the corresponding format.

When you want to pull out the card, first push it, and then pull it out.

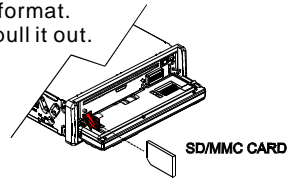

#### 5.19 The DVD System Menu Setup Operation

1. Press the SETUP button on the remote control to access the DVD System Menu on the monitor.
2. There are 6 setup pages in all for the System Menu. Press the > or < button to select a desired setup page.
3. Press the ^ or ∨ button to select an setup item in the selected setup page.
4. Press the > button to enter the setup item. Then press the ∨ or ^ button to select a desired mode of the setup item, finally press the OK button to confirm it.
- \* Press the < button to return to the upper level.
- \* Press the SETUP button again or use the direction buttons to highlight the item of the EXIT SETUP and then press the OK button to exit the System Menu.

## 4. Basic Disc, USB or MMC/SD Operation

### 4.1 Begin playback

#### 1. Press the POWER button briefly to turn on the DVD player.

After turning on the DVD player, please turn on the monitor, and ensure that the video output of the monitor is the video input from the DVD player connected with the monitor.

#### ? Common Question

Q: There is not anything is displayed on TV screen when the DVD player is turned on. How to solve the problem?

A: Ensure that the TV was set to right video input(not TV channel); for example, if you make VIDEO1 INPUT of TV and DVD player connected with each other, then you need set TV to VIDEO1.

#### 2. Press the RELEASE button to detach the front panel from the unit.

#### 3. Insert a disc into the DISC SLOT(Label surface up), then flip up the front panel till hearing a clip.

### ! NOTE

1. For some discs that are seriously scratched or poor manufacturing or recording quality, it may not play.
2. If the player can not read disc under normal condition, please try to eject and reload the disc again.
3. Remark:
  - 1) In addition to normal CD and DVD, this unit supports to play CD-R, CD-R/W, DVD-R and DVD-R/W as well; however, depending on the conditions of the recording equipment, recording program or the disc itself, some CD-R, CD-R/W, DVD-R or DVD-R/W may not play.
  - 2) When dealing with CD-R, CD-R/W, DVD-R or DVD-R/W recording, too high recording speed may result in poor signal quality and therefore, it is recommendable to select as lower as possible recording speed.

#### 4.2 Pause Playback

In the state of DVD/VCD/CD/MP3/WMA disc playing, press the PAUSE button on IR remote control to pause the playback, press the PLAY button to resume normal playback.

#### 4.3 Stop Playback

In the state of DVD/VCD/MP3/WMA/CD disc playing, press the STOP button once to pause the playback, then press the PLAY button to resume the normal playback; press the STOP button twice to full stop the playback, then press the PLAY button to start playback from the beginning of the first chapter/track.

#### 4.4 Select Chapter/Track with the UP/DN or the >>| / |<< Button

Press the UP/DN button on the front panel or the >>| / |<< button on the remote control during playback to select the next or last chapter/track to playback.

Note: Press the UP/DN or the >>| / |<< button multiple times to advance multiple chapters/tracks forward or backward.

#### 4.5 Select Chapter/Track with the Number Buttons

In the state of DVD/VCD(PBC OFF)/MP3/WMA/CD disc playing, press one of the 1~9 and the 0/10 number buttons to directly select and play the 1st to 10th track/chapter (the 0/10 button is used as the 10 button).

If you want to play the track/chapter that's serial number is bigger than 10, use the 10+, 1~9 and 0/10 button. For example 1, to play the 13th track/chapter, firstly press the 10+ button once, then press the 3 button. For example 2, to play the 34th track/chapter, firstly press the 10+ button for 3 times, then press the 4 button. (the 0/10 button is used as the 0 button)

Note: long pressing the +10 or -10 button can play the next 10 or last 10 chapter/track (only for MP3/WMA).

#### 4.6 Select Chapter/Track with the Root/PBC Menu (If the disc includes the root/PBC menu)

In the state of DVD disc playing

1. Press the TITLE button on the remote control to display the title list.
  2. Press the direction buttons to select your desired title, and then press the OK or PLAY button to open the root menu of the selected title.
  3. Press the direction buttons to select your desired chapter, finally press the OK or PLAY button to play the selected chapter.
- During playback, pressing the MENU button can directly display the root menu of the title that is playing.

#### 5.14 Program Playback

It allows you to enter the order in which you want some chapters/tracks in DVD/VCD/MP3/WMA/CD disc to play.

1. During playback, press the PROG button to enter a program interface as follows:

for DVD discs

PROGRAM			
T	C	T	C
1	5	9	13
2	6	10	14
3	7	11	15
4	8	12	16
Play Clear			

for VCD/MP3/WMA/CD discs

PROGRAM			
1	5	9	13
2	6	10	14
3	7	11	15
4	8	12	16
Play Clear			

2. Use the direction buttons to move cursor onto the desired place for inputting the sequence number.
  3. Use the number button to input desired sequence number of title/chapter/track with desired sequence.
  4. Use the direction button to move cursor onto Play item, then press the OK button to play the programmed titles/chapters/tracks in programmed order; only pressing the PLAY button also can play the programmed titles/chapters/tracks in programmed order.
- \* To exit program playback, first press the STOP button, then press the PLAY button to enter sequence playback; or press the PROG button twice again.
  - \* To remove the all programmed sequence numbers, move the cursor onto Clear item, then press the OK button.
  - \* To change the programmed sequence, move the cursor onto the item you want to change, input the desired sequence number.
  - \* During VCD playback, if it is in PBC ON mode, at the same time of entering the state of program playback, it turns off PBC mode.

#### 5.15 Playback the Picture CD in JPEG Format

1. The root menu is displayed on the monitor when beginning to switch on DISC mode. At the time, it plays MP3/WMA file. (the TITLE or MENU button is not available).  
In the root menu, the left file sort icon is for MP3/WMA file; the middle file sort icon is for JPEG file; the right file sort icon is for VIDEO file. If one of these 3 file sort does not exist, you cannot move cursor onto the file sort icon.
2. When displaying the root menu, press the direction buttons to select your desired FOLDER, file or file sort icon, then press the OK or PLAY button to open the FOLDER, or play only this sort of file.  
When displaying the root menu, you can also use the number buttons to select the serial number of the file and play the file.  
When you select a JPEG file sort icon, press the ^ or > button to select the first JPEG file, then press the v button to select the desired JPEG file, finally press the OK or PLAY/PAUSE button to display the JPEG picture in full screen from the selected JPEG picture.

ZOOMx2,ZOOMx3,ZOOMx4,ZOOMx1/2,ZOOMx1/3,ZOOMx1/4,ZOOM OFF.  
Press one of the  $\wedge/v/>/<$  buttons to select the area you want to enlarge.

#### 5.10 Change the Caption Language

When playing a DVD disc, press the SUBTITLE button repeatedly to select the language of the caption or turn off the caption.(depend on the current disc)

When playing a VCD/MP3/WMA/CD disc, the button is not available.

#### 5.11 Change the Audio Language

1. When playing a DVD disc, press the AUDIO button repeatedly on the remote control to select the desired language type. (depend on the current disc)
2. When playing a VCD disc, press the AUDIO button repeatedly to select the sound mode of the MONO L, MONO R, MIX MONO and Stereo, no language function.
3. When playing a CD/WMA/MP3 disc, the AUDIO button is disabled.

#### 5.12 Change the Video Signal System

During playback of DVD/VCD disc, press the BAND(P/N) button on the front panel or on the remote control repeatedly to change the VIDEO SIGNAL SYSTEM mode.

#### 5.13 Look over the Playback Status

1. When playing a DVD disc, press the OSD button repeatedly on the remote control to turn on/off the playback status. When it is on, it will display the information such as: the serial number of the playing title, the serial number of the playing chapter, the elapsed time of the playing chapter, the remained time of the playing chapter, the elapsed time of the playing title, the remained time of the playing title, etc.
2. When playing a VCD/CD disc, press the OSD button repeatedly on the remote control to turn on/off the playback status. When it is on, it will display the information such as: the serial number of the playing track, the elapsed time of the playing track, the remained time of the playing track, the elapsed time of the disc, the remained time of the disc.
3. When playing a MP3/WMA disc, press the OSD button repeatedly on the remote control to turn on/off the playback status. When it is on, it will display the information such as: the serial number of the playing track, the elapsed time of the playing track, the remained time of the playing track.

In VCD mode

1. When starting to turn on the PBC function, it will play from the beginning of the disc till it display the PBC menu on monitor screen if the disc include the PBC menu.
2. Press the number buttons to select your desired track to play.

In MP3/WMA mode

1. The root menu is displayed on the monitor screen all the time(and the TITLE or MENU button is not available).
2. Press the direction buttons to select your desired FOLDER, then press the OK or PLAY button to open the FOLDER, and then press the direction buttons to select your desired file, finally press the OK button to play the selected file.

In CD mode, the TITLE, PBC, MENU buttons are disabled.

#### 4.7 Terminate the Playback

1. Press the EJECT button to slide down the front panel, then the disc in the disc compartment will come out automatically. and then remove the disc away.
2. Long press the POWER button on the front panel or briefly press the POWER button on the remote control to turn off the DVD player.

### 5. Advanced Disc, USB or MMC/SD Operation

#### 5.1 Playback with Speed

During normal playback, long press the UP/DN button on the front panel or the  $\gg/|<<$  button on the remote control continuously to fast forwards or backwards at the following speeds: x2, x4, x8, x20, normal.

During speed playback, press the PLAY button to resume normal playback.

#### 5.2 Playback with Slow Speed

During playback, press the SLOW\_FWD button to execute the Slow Forward function.

With each consecutive pressing of the SLOW\_FWD button, the playback speed decreases. The speed levels in Slow Forward as follows: x1/2,x1/3,x1/4,x1/5,x1/6,x1/7,normal.

During slow forward, press the PLAY button to resume normal playback.

This function is only for video.

### 5.3 Playback with still frame

If the unit is currently playing DVD/VCD disc, press the STEP button consecutively to display the still frame forward with step by step.

Press the PLAY button to resume normal playback.

### 5.4 Playback Repeatedly

#### 5.4.1 ONE/ALL Repeat

1. In the mode of DVD disc playback:  
Press the RPT button to select REP CHAPTER, REP TITLE, REP ALL or REP OFF.
2. In the mode of VCD(PBC OFF)/CD disc playback:  
press the RPT button to select REP ONE, REP ALL or OFF.  
When it is in the state of PBC ON, during VCD disc playing, the RPT button are not available.
3. In the mode of MP3/WMA disc playback:  
Press the RPT button to select REP ONE, REP DIR, REP ALL or OFF.

#### 5.4.2 A-B Repeat

Press the **A-B** button if you want to repeat a specific segment on a disc that you define:

1. Press the **A-B** button at a point (A) where you want it to be the start point of the repeat segment. Press the **A-B** button again at a point (B) where you want it to be the terminal point of the repeat segment. Then it will play the segment repeatedly.
2. To cancel the A-B repeat mode and resume normal playback, press the **A-B** button for the third time.

Note:

During VCD/MP3/WMA/CD playback, points A and B must be within the same track.

During DVD playback, points A and B can be selected from different chapters.

### 5.5 Playback in Scan Mode

1. When playing a VCD(PBC OFF)/CD disc, press the INT button to play the previous 15 seconds part of each track on the disc. Press the INT button again to resume normal playback.
2. When playing a DVD/MP3/WMA disc, the INT button is not available.

### 5.6 Playback from a specified chapter/track or a specified time

1. When playing a DVD disc , press the SEARCH button to display a interface and highlight the title item, then use the number buttons to input the serial number of the title; use the direction buttons to highlight the chapter item, then use the number buttons to input the serial number of the chapter; you can still use the direction buttons to highlight the time item, then use the number buttons to input the desired time to start playback; finally press the OK or PLAY button to play the selected chapter or play from the selected time.
2. When playing a VCD/MP3/WMA/CD disc , press the SEARCH button to display a interface and highlight the track item, then use the number buttons to input the serial number of the track; you can still use the direction buttons to highlight the time item, then use the number buttons to input the desired time to start playback; finally press the OK or PLAY button to play the selected track or play from the selected time.

### 5.7 Playback in Random

When playing DVD/VCD(PBC OFF)/MP3/WMA/CD disc , press the RDM button to switch between RANDOM (ON)/RANDOM OFF. When in RANDOM (ON) mode, it will play in random.

### 5.8 Playback in Different Angle

1. When playing a VCD/MP3/WMA/CD disc , the ANGLE button on the remote control is not available.
2. When playing a DVD disc , press the ANGLE button repeatedly on the remote control to view in different angle.(This function is only for the DVD discs with ANGLE function)

### 5.9 Playback in Zoom Mode

In DVD/VCD mode, during playback, press the ZOOM button continuously to enlarge a certain area of the images on the screen with these multiples: